

PUERTA BATIENTE

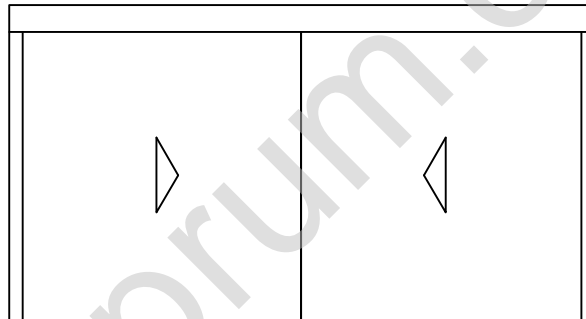

PUERTA CORREDIZA

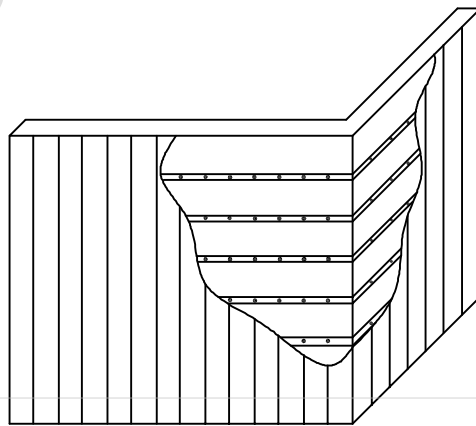

MURO RECUBIERTO

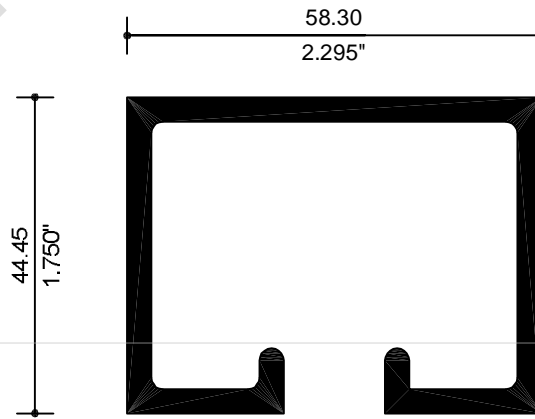
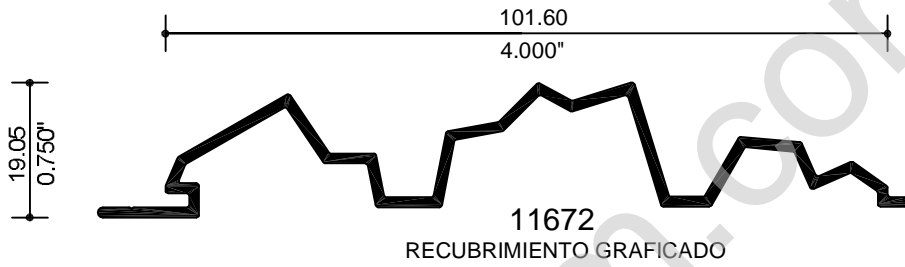
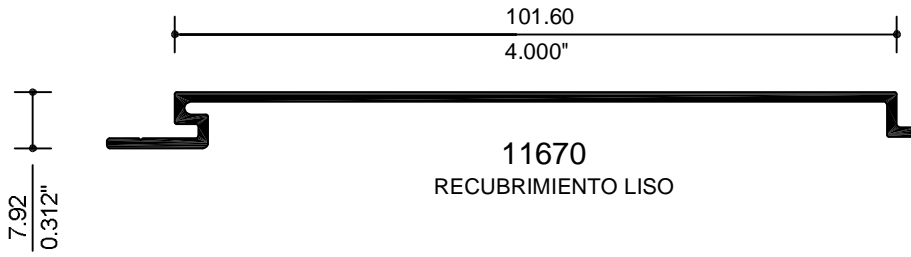

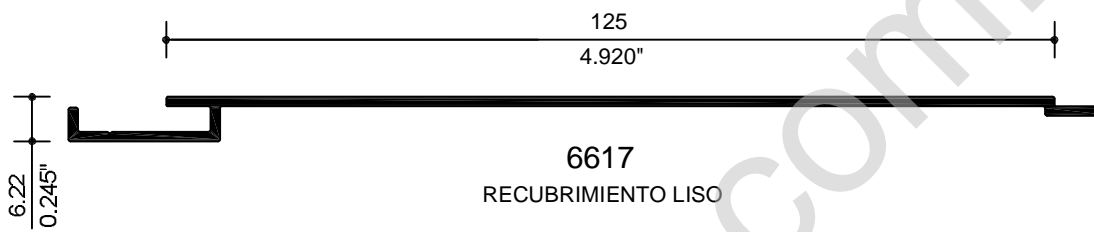
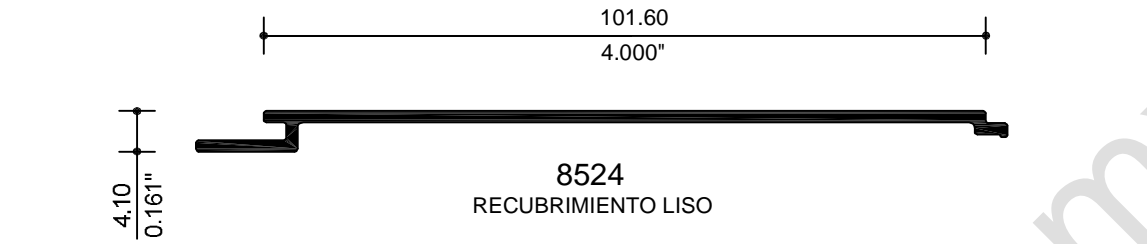

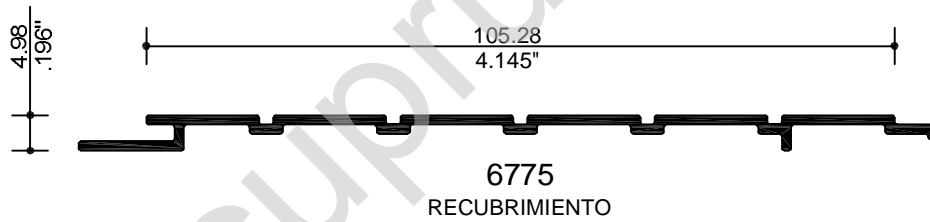
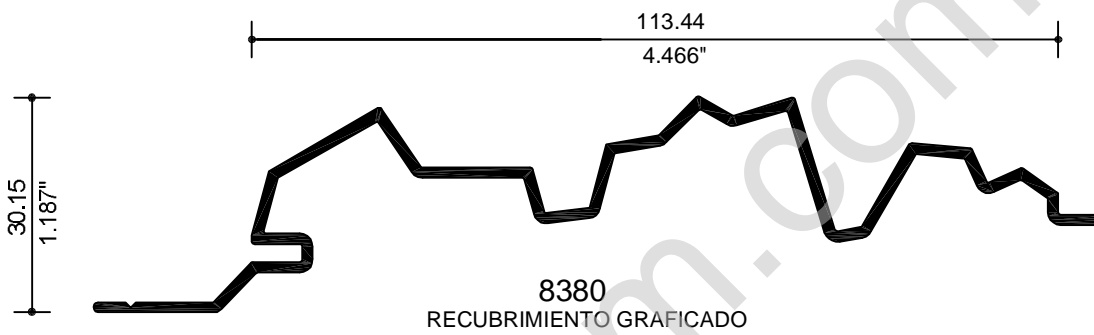
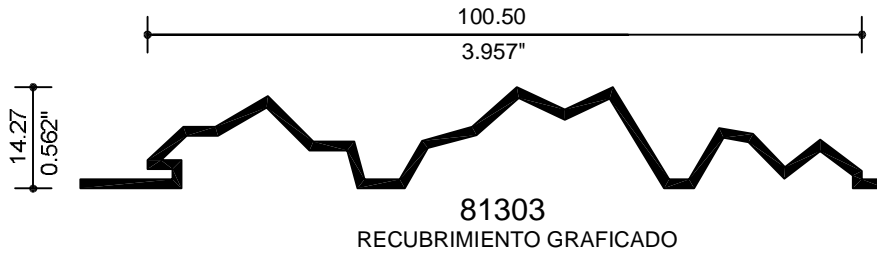

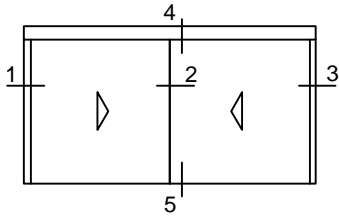

PUERTA CORREDIZA

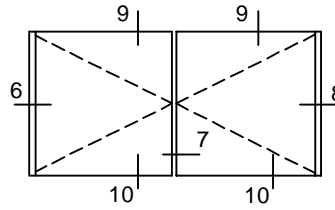

PUERTA BATIENTE

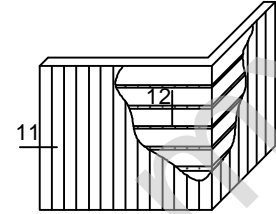

MURO RECUBIERTO

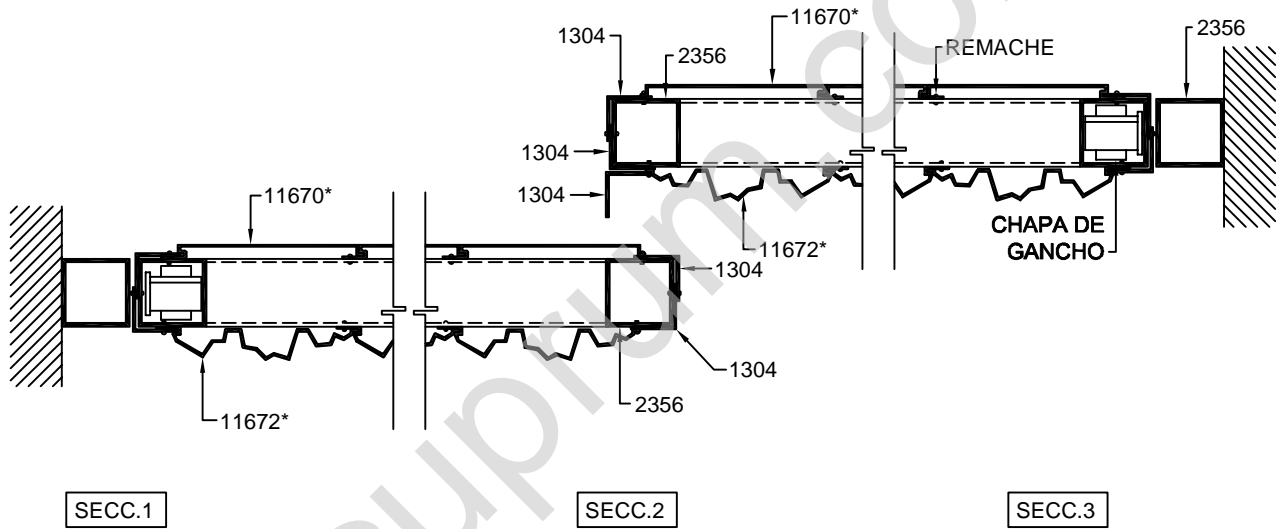

EXTERIOR

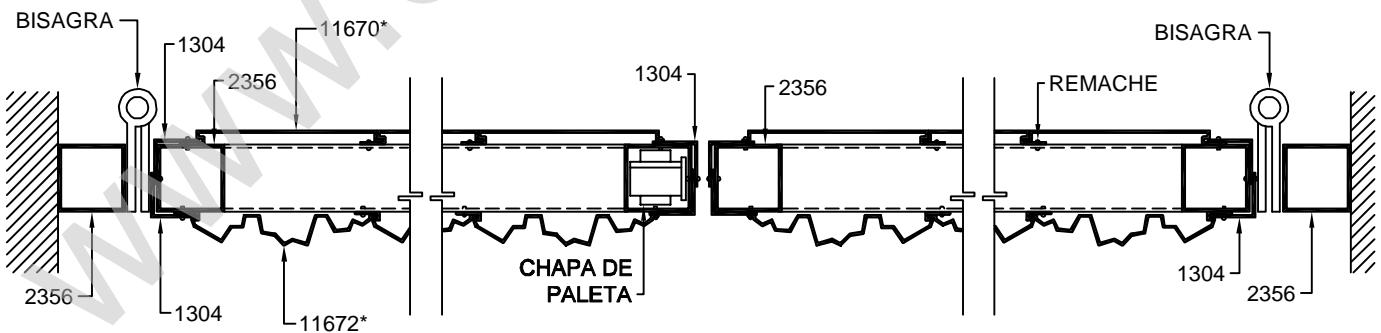

EXTERIOR

*NOTA: EL RECUBRIMIENTO MOSTRADO ES OPCIONAL

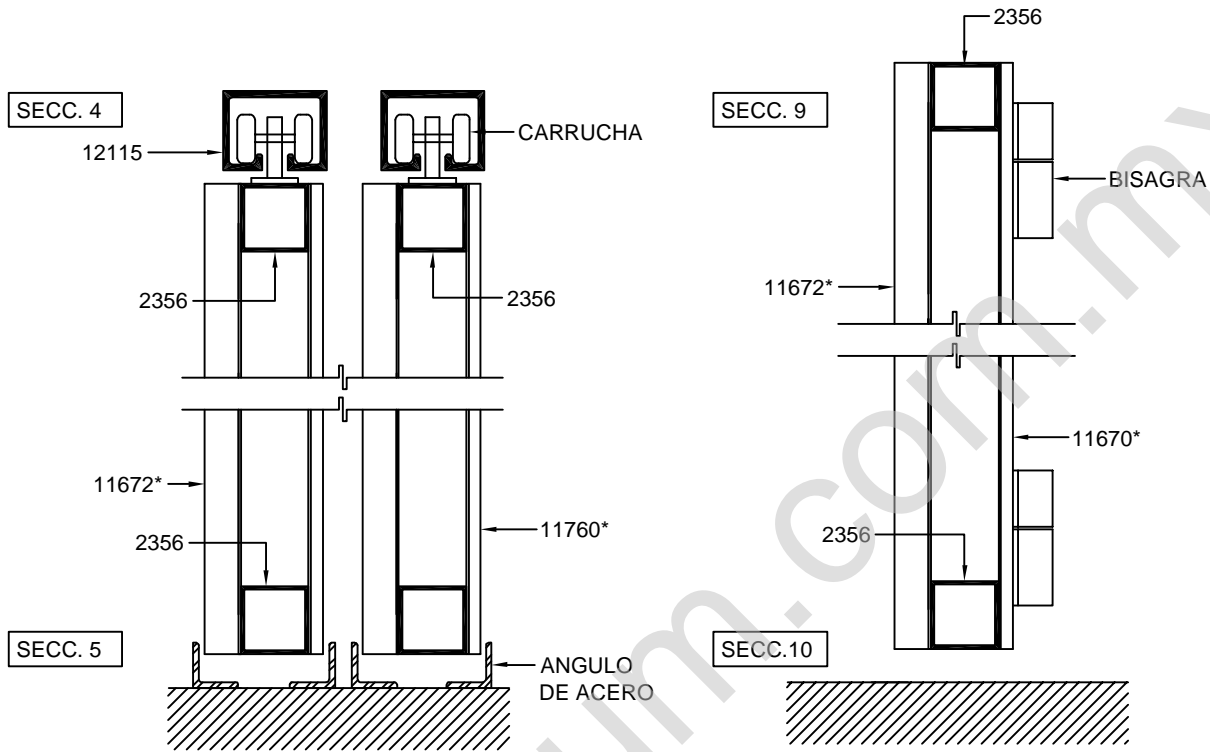

NOTA: LA ESTRUCTURA DE LAS PUERTAS CORREDIZA O BATIENTE SE ARMA:

- a).- CON TUBO DE ALUMINIO Y TENSORES.
- b).- CON TUBO DE ACERO SOLDADO Y PINTADO DE ANTICORROSIVO.

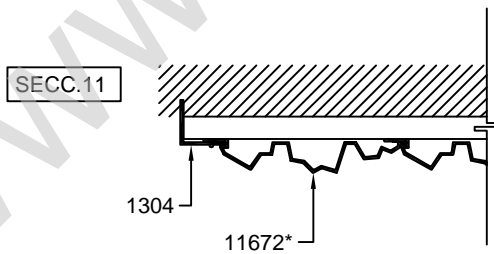



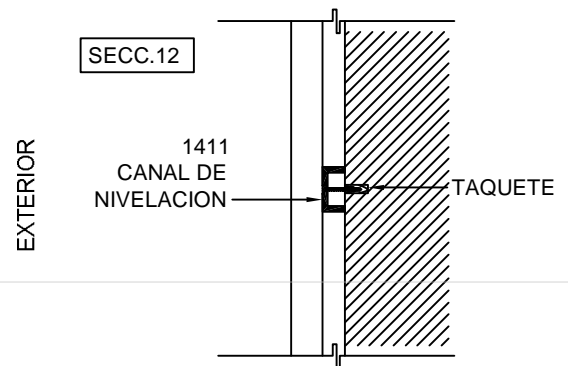











EXTERIOR



ALUMINIO

CLAVE	PZAS POR ATADO	LARGO STD.
66617	6	6.10
6617	6	6.10
6775	8	6.10
8068	8	6.10
8380	6	6.10
8524	8	6.10
9528	8	6.10
11128	8	6.10
11670	8	6.10
11671	8	6.10
11672	8	6.10
12115	2	6.10
13562	8	6.10
81303	8	6.10
81581	8	6.10

RENDIMIENTO POR M
DE RECUBRIMIENTOS

CLAVE	FIGURA	MEDIDA
66617		5.000"
6617		5.000"
6775		4.000"
8068		3.500"
8380		4.500"
8524		4.000"
9528		5.000"
11128		5.000"
■ 11670		4.000"
■ 11671		4.000"
■ 11672		4.000"
13562		6.000"
81303		4.000"
81581		5.000"

■ RECUBRIMIENTOS COMPATIBLES